

YOUR
SMART
ENERGY

STORION-G2-H30-O

COMMERCIAL &
INDUSTRIAL SERIES

POWER

30 kW Hybrid Inverter

CAPACITY

8.0 kWh Battery Module
64.5 ~ 96.7 kWh



KEY FEATURES

- **All in One Design**
The cabinet contains batteries, PCS, DC/DC, STS, and EMS, but only occupies a small area.
- **Support Multi-Direction Roof**
PV Input: 4*MPPT with 200V ~ 850V MPPT Voltage
- **Multiple System Operation Monitoring**
Local SCADA Monitoring & Remote Commercial and Industrial Cloud
- **Max 5 systems in on-grid parallel, 3 systems in off-grid parallel**
Single system switching time $\leq 20\text{ms}$, parallel system switching time $\leq 100\text{ms}$

STORION-G2-H30-O



System Functions

Backup

Max 5 Systems in Parallel

Peak Shaving and Load Shifting

Timed Charge and Discharge

System Diagram

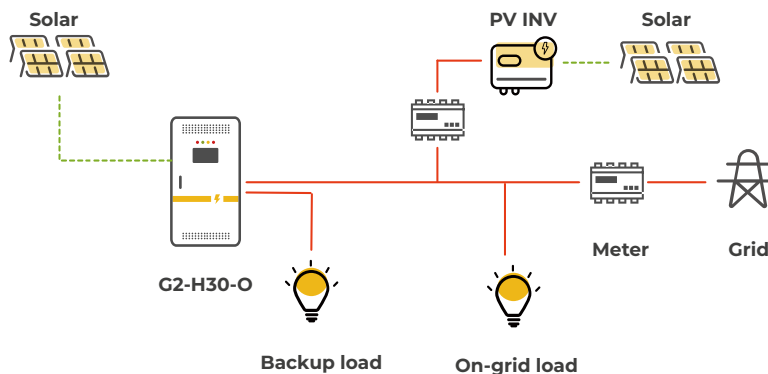

Model

STORION-G2-H30-O

System Technical Specifications

Battery Chemistry	LiFePO4
Battery Energy Range	64.5 ~ 96.7 kWh
Depth of Discharge(DOD)	90% (On-Grid), 85% (Off-Grid)
IP Protection	IP55
Standard Battery Cluster	1*
Warranty	5 Years Product Warranty, 10 Years Battery Performance Warranty

PV Side

Max. input power	45 kW
Start-up voltage	135 V
MPPT Voltage Range	200 ~ 850 V
Number of MPPT	4
Number of Strings for Each MPPT	2
Max. Input Current	30 A / 30 A / 30 A / 30 A
Max. Short-circuit Current	40 A / 40 A / 40 A / 40 A

AC Data(Grid)

Rated Output Power	30 kW
Max. Input Power	36 kW
Rated Grid Voltage	3L / N / PE 220 V / 380 V; 230 V / 400 V
Grid Frequency	50 / 60 Hz
Rated Current	50 A
Output THDi	< 3%
AC PF	0,8 leading ... 0,8 lagging

AC Data (Backup)

Rated Output Power	30 kW
Max Output Apparent Power	33 kVA
Rated Grid Voltage	3L / N / PE 220 V / 380 V; 230 V / 400 V
Grid Frequency	50 / 60 Hz
Max Current	50 A

General Data

Dimensions(W x D x H)	(1200+300) x 900 x 2160 mm
Weight	1072 ~ 1397 kg (with M38210-SC)
Operating Temperature Range	-20 °C ~ 50 °C (PCS > 45°C derating)
Relative Humidity	0 ~ 95% (No Condensation)
Max. Working Altitude	3000 m / 9842 ft (>3000 m derating)
Cooling Method	Forced Air-Cooling
Communication Interfaces	RS485, CAN, Modbus TCP, Ethernet
Display	SCADA
Certifications	IEC 62477, IEC 61000, IEC 62109, EN 50549-1, VDE 4105, G99, G100, C10/C11**, TOR Erzeuger**, NC RFG, UNE 217001/2**, CEI-021/016

* Max support 2 battery clusters, extra battery cabinet is needed.

** The certification process is ongoing.

STORION-G2-H30-O



Model	STORION-G2-H50-O
Battery Cluster System	

Item	Data	
-------------	-------------	--

Battery Module	M38210-SC 0.5C
Battery Chemistry	LiFePO4
Pack	3.2 V / 105 Ah@2P12S
Internal Resistance	≤ 10 mΩ
Nominal Capacity	8064 kWh
Rated Voltage	38.4 V
Operating Voltage	36 V ~ 43.2 V
Max. Charging/Discharging Current	105 A
System Cycle Life	6000*
Operating Temperature Range	-10 °C ~ 50 °C**
IP Protection	IP21
Communication	CAN
Dimensions (W x D x H)	325 x 658 x 232 mm
String Pack QTY	8 - 12
Certifications	IEC 62619, IEC 62477, IEC 61000

Meter (Optional)



Model	DTSU666
Rated Voltage	230V AC / 400V AC
Accuracy Class	± 1%
Communication	RS485, Modbus, RTU
Dimensions (W×D×H)	72×80×101 mm
CT Model	AKH-0.66, K-30×20
CT Current Ratio	400 / 5 A
CT Perforation Size	32×22 mm

Expansion Battery Cluster (Optional)



Model	ALPBC-105-O
Battery	M38210-SC
Cluster Capacity	64.51 ~ 96.76 kWh
Max. Charging / Discharging Current	105 A
Battery Cluster Voltage Range	432 V ~ 518.4 V
Battery Rack	2 x 6
Fire-Fighting System	Aerosol+Smoke/Temperature
Dimensions (W×D×H)	1200 x 900 x 2160 mm
Weight	980 ~ 1240 kg

* Under specific test conditions.

** Max. charge/discharge current derating may occur with changes in temperature and SoC.







"BIGGER & STRONGER"

Commercial & Industrial Solution Supports Your Business



AlphaESS is a world-leading energy storage solution and service provider covering the full power range.

 @AlphaEnergyStorageSystem  @AlphaESS  @alpha_ess  @AlphaESS  www.alphaess.com

 +86 513 8060 6891
 info@alpha-ess.com
 www.alphaess.com
 No. 1086, Bihua Road,
Nantong Hi-Tech Zone,
Jiangsu Province, China



 +49 6196 7863485
 europe@alpha-ess.de
 www.alphaess.de
 Horizon Tower 17.0G
Alfred-Herrhausen-Allee 3-5
65760 Eschborn, Germany



 +61 02 9000 7676
 techsupport@alphaess.au
 www.alphaess.com
 8/15-21 Gibbes Street,
Chatswood,
NSW 2067 Australia



 +1 408 368 7828 usa@al-
pha-ess.com
 Unit 5 2180 S Ivanhoe St,
Denver, CO 80222 USA

 +65 6513 1125 / +65 6513 1126
 Singapore@alpha-ess.com
 2 Corporation Road #01-06A
Corporation Place 618494
Singapore

 +39 339 462 4288
 info@alphaess.it
 www.alphaess.com
 Via Del Molinuzzo 83,
59100 Prato (PO), Italy

 +44 0330 043 2610
 info@alpha-ess.com
 Drake house, Long street,
Dursley, GL11 4HH UK

 info@alpha-ess.com
 2F, 19-4, Nohyeong 11-gil,
Jeju-si, Jeju-do, Republic
of Korea

 measervice@alpha-ess.com
 La Rocca Office Park, Block
B1 321 Main Road, Bryanston,
Johannesburg, 2191